

CHAPTER 5

◆◆ Flat Fan Nozzles

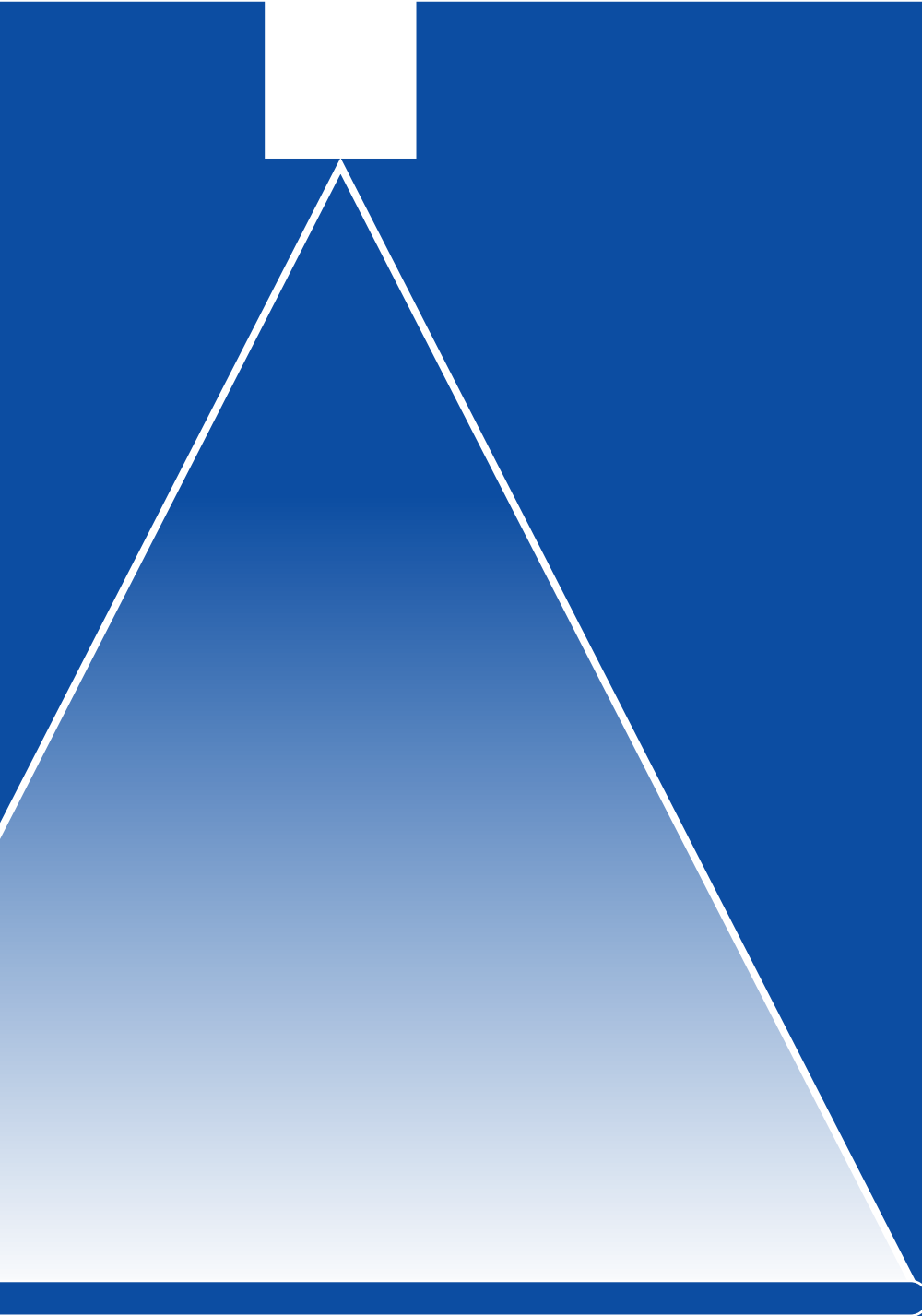

◆ ABOUT US

We Are Here to Help

• Welcome to SPADFLOW

facing the **Challenges** of new industries and emerging markets.

• Spray Technologies

with over **Thousands of Spray Nozzle Types** SPADFLOW has become Iran's leading producer.

• From Design to Installation

with **Skilled** engineers and project managers, SPADFLOW is providing consultancy and support services.

• Knowledge and Experience

as an **Expert** on spray technology, SPADFLOW is at the forefront of production and innovation.





PRODUCT NUMBERS

Everything You Need to Know

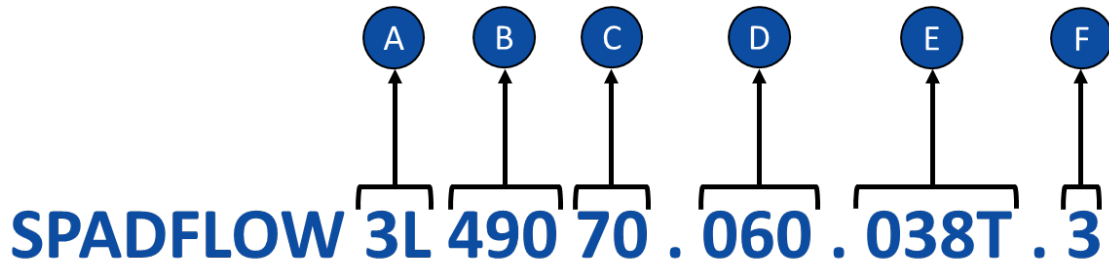

A

Nozzle Type (Spray Pattern)

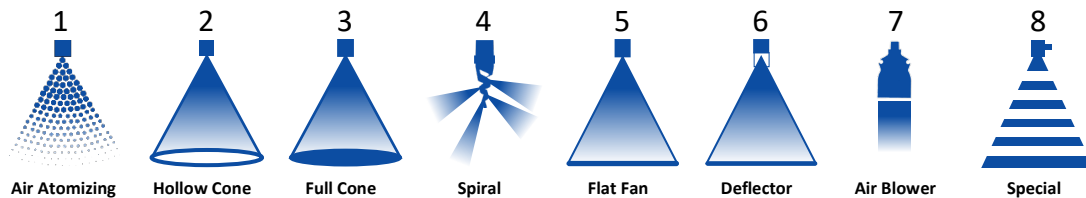

B

Nozzle Series

C

Flow Rate Rank

The flow rate rank is relative and depends on the respective nozzle type. The exact value is mentioned in tables on the product pages.

D

Spray Angle

Theoretical spray angle is mentioned in tables on the product pages. Actual spray angle depends on installation and alignment.

- A = Theoretical Spray Angle
- D = Spray Distance
- C = theoretical Spray Coverage

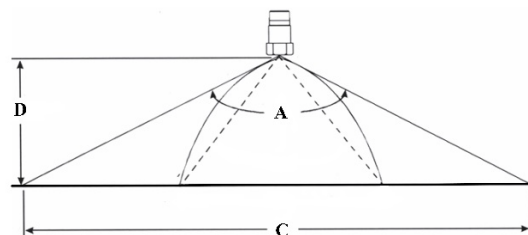

PRODUCT NUMBERS

Everything You Need to Know

E

Connection

1/8" to 4" connections. The exact specification is mentioned in tables on the product pages.
 T = BSBT Thread Type Connection
 P = BSPP Thread Type Connection
 N = NPT Thread Type Connection
 R = Retaining Nut

F

Material

Material	Code	Material	Code
Brass	1	Polyvinylchloride	PVC
AISI 304/304L Stainless Steel	2	Polypropylene	PP
AISI 316/316L Stainless Steel	3	Polyamide	PA
AISI 310 Stainless Steel	4	Polyvinylidene fluoride	PVDF
AISI 321 Stainless Steel	5	Polytetrafluorethylene	PTFE
AISI 420 Stainless Steel	6	Polyoxymethylene	POM
Tungsten Carbide	TN	Nitrile Butadiene Rubber	NBR
Phosphor Bronze	CuSn	Polylactic Acid	PLA
Copper	Cu	Acrylonitrile Butadiene Styrene	ABS
Titanium	TI	Nylon Polyamide	PA6
Aluminum	AL	Polycarbonate	PC

Ø B (Equivalent Bore Diameter)

Applies to elliptical discharge holes of flat fan nozzles. A cylindrical hole with a diameter A has the same surface area as the ellipse.

Ø E (Narrowest Free Cross Section)

Important Characteristics for determining the pre-filtration of a nozzle. Can be less than a due to several swirl ducts.

Conversion Formula: $K \text{ factor} \times \sqrt{P(\text{bar})} = Q (\text{l/min})$

All flow rate data in this catalogue is based on measurements with water,

Spray angle (α)	Code	Connection Size [inch]	Ø B [mm]	Ø E [mm]	Flow rate (Q) [l/min]						
					Pressure (P) [bar]						
					0.5	1.0	2.0	3.0	5.0	7.0	10.0
45°	3L 490 40 . 045	1/8"	1.25	1.25	0.57	0.76	1.00	1.18	1.44	1.65	1.90
	3L 490 60 . 045	1/4"	2.00	2.00	1.81	2.39	3.15	3.70	4.54	5.20	6.00
	3L 490 70 . 045	3/8"	2.65	2.65	3.22	4.24	5.60	6.59	8.08	9.24	10.66
	3L 490 78 . 045	1/2"	3.45	3.45	5.17	6.82	9.00	10.58	12.98	14.85	17.12
60°	3L 490 40 . 060	1/8"	1.15	1.15	0.57	0.76	1.00	1.18	1.44	1.65	1.90
	3L 490 80 . 060	3/8"	3.70	3.70	5.74	7.58	10.00	11.76	14.43	16.51	19.04
	3L 490 88 . 060	1/2"	4.65	4.65	9.19	12.13	16.00	18.82	23.08	26.41	30.46
	3L 490 96 . 060	3/4"	5.80	5.80	14.36	18.95	25.00	29.40	36.07	41.26	47.59
	3L 491 08 . 060	1"	8.15	8.15	28.72	37.89	50.00	58.80	72.14	82.53	95.18

SPADFLOW spray nozzles are manufactured with the highest precision and undergo permanent quality checks. However, production-related tolerances can affect the spray angle, flow rate, droplet size and droplet distribution.



SPADFLOW 5L 664/665

Parabolical Distribution Flat-Fan Nozzle

Webpage
+ STP

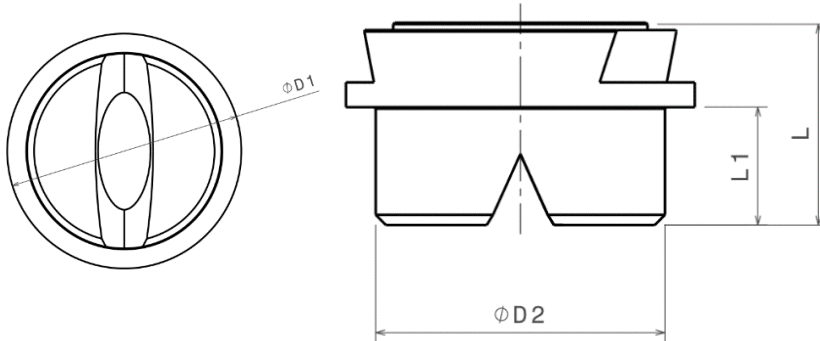

G1	Dimensions [mm]				Weight
	L	L1	D1	D2	
Retaining Nut 3/4"	14.0	8.0	24.0	20.0	13 gr

Material*	Code
Brass	1
S.S.304	2
S.S.316	3

* Different materials are available upon request

Properties:

- One - Piece Construction
- Non-Clogging Nozzle
- Uniform, Parabolic Liquid Distribution
- Stable Spray Angle

α	Spray coverage @ 250 mm
20°	100 mm
30°	140 mm
45°	220 mm
60°	280 mm
90°	520 mm
120°	890 mm

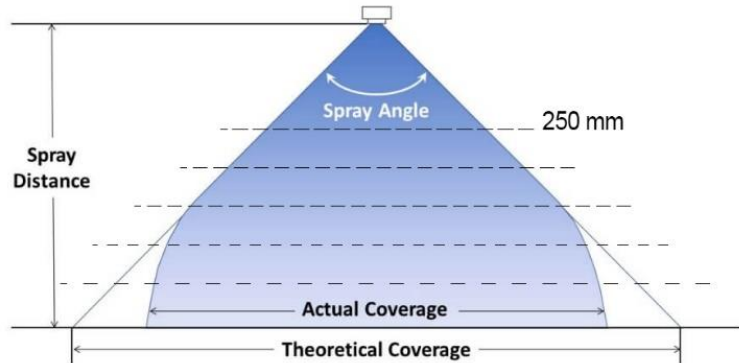

Spray angle (α)	Code	A ϕ [mm]	E ϕ [mm]	Flow rate [l/min]					
				P [bar]					
				0.5	1.0 <i>K factor</i>	2.0	3.0	5.0	10.0
20°	5L 664 72 . 020	3.00	2.50	3.15	4.45	6.30	7.72	9.96	14.09
	5L 664 80 . 020	4.00	3.20	5.00	7.07	10.00	12.25	15.81	22.36
	5L 664 88 . 020	5.00	4.00	8.00	11.31	16.00	19.60	25.30	35.78
	5L 664 92 . 020	5.50	4.40	10.00	14.14	20.00	24.49	31.62	44.72
	5L 664 96 . 020	6.00	5.10	12.50	17.68	25.00	30.62	39.53	55.90
30°	5L 664 72 . 030	3.00	2.40	3.15	4.45	6.30	7.72	9.96	14.09
	5L 664 76 . 030	3.50	2.70	4.00	5.66	8.00	9.80	12.65	17.89
	5L 664 80 . 030	4.00	3.10	5.00	7.07	10.00	12.25	15.81	22.36
	5L 664 88 . 030	5.00	4.00	8.00	11.31	16.00	19.60	25.30	35.78
	5L 664 92 . 030	5.50	4.40	10.00	14.14	20.00	24.49	31.62	44.72
	5L 664 96 . 030	6.00	5.00	12.50	17.68	25.00	30.62	39.53	55.90
	5L 665 04 . 030	8.00	6.40	20.00	28.28	40.00	48.99	63.25	89.44
5L 665 12 . 030	10.00	8.20	31.50	44.55	63.00	77.16	99.61	140.87	



SPADFLOW 5L 664/665

Parabolical Distribution Flat-Fan Nozzle

Webpage
+ STP

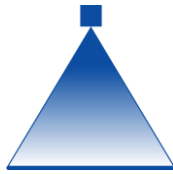

Spray angle (α)	Code	A Ø [mm]	E Ø [mm]	Flow rate [l/min]					
				P [bar]					
				0.5	1.0 <i>K Factor</i>	2.0	3.0	5.0	10.0
45°	5L 664 72 . 045	3.00	2.40	3.15	4.45	6.30	7.72	9.96	14.09
	5L 664 76 . 045	3.50	2.60	4.00	5.66	8.00	9.80	12.65	17.89
	5L 664 80 . 045	4.00	3.00	5.00	7.07	10.00	12.25	15.81	22.36
	5L 664 84 . 045	4.50	3.40	6.25	8.84	12.50	15.31	19.76	27.95
	5L 664 88 . 045	5.00	3.80	8.00	11.31	16.00	19.60	25.30	35.78
	5L 664 92 . 045	5.50	4.20	10.00	14.14	20.00	24.49	31.62	44.72
	5L 664 96 . 045	6.00	4.40	12.50	17.68	25.00	30.62	39.53	55.90
5L 665 04 . 045	8.00	5.90	20.00	28.28	40.00	48.99	63.25	89.44	
60°	5L 664 72 . 060	3.00	2.10	3.15	4.45	6.30	7.72	9.96	14.09
	5L 664 76 . 060	3.50	2.30	4.00	5.66	8.00	9.80	12.65	17.89
	5L 664 80 . 060	4.00	2.60	5.00	7.07	10.00	12.25	15.81	22.36
	5L 664 84 . 060	4.50	3.00	6.25	8.84	12.50	15.31	19.76	27.95
	5L 664 88 . 060	5.00	3.40	8.00	11.31	16.00	19.60	25.30	35.78
	5L 664 92 . 060	5.50	4.10	10.00	14.14	20.00	24.49	31.62	44.72
	5L 664 96 . 060	6.00	4.20	12.50	17.68	25.00	30.62	39.53	55.90
	5L 665 04 . 060	8.00	5.50	20.00	28.28	40.00	48.99	63.25	89.44
	5L 665 08 . 060	9.00	6.20	25.00	35.36	50.00	61.24	79.06	111.80
5L 665 12 . 060	10.00	7.40	31.50	44.55	63.00	77.16	99.61	140.87	
90°	5L 664 72 . 090	3.00	1.70	3.15	4.45	6.30	7.72	9.96	14.09
	5L 664 76 . 090	3.50	1.90	4.00	5.66	8.00	9.80	12.65	17.89
	5L 664 80 . 090	4.00	2.40	5.00	7.07	10.00	12.25	15.81	22.36
	5L 664 84 . 090	4.50	2.40	6.25	8.84	12.50	15.31	19.76	27.95
	5L 664 88 . 090	5.00	3.10	8.00	11.31	16.00	19.60	25.30	35.78
	5L 664 92 . 090	5.50	3.60	10.00	14.14	20.00	24.49	31.62	44.72
	5L 664 96 . 090	6.00	3.90	12.50	17.68	25.00	30.62	39.53	55.90
	5L 665 04 . 090	8.00	4.90	20.00	28.28	40.00	48.99	63.25	89.44
5L 665 12 . 090	10.00	6.40	31.50	44.55	63.00	77.16	99.61	140.87	
120°	5L 664 72 . 120	3.00	1.60	3.15	4.45	6.30	7.72	9.96	14.09
	5L 664 76 . 120	3.50	1.70	4.00	5.66	8.00	9.80	12.65	17.89
	5L 664 80 . 120	4.00	2.00	5.00	7.07	10.00	12.25	15.81	22.36
	5L 664 88 . 120	5.00	2.60	8.00	11.31	16.00	19.60	25.30	35.78
	5L 664 92 . 120	5.50	2.90	10.00	14.14	20.00	24.49	31.62	44.72
	5L 664 96 . 120	6.00	3.20	12.50	17.68	25.00	30.62	39.53	55.90
	5L 665 04 . 120	8.00	4.40	20.00	28.28	40.00	48.99	63.25	89.44